

# Wagner

**ELECTRONIC SERVICES A/Asia**  
**138 LIVERPOOL RD ASHFIELD 2131**  
**PH 02 97989233 FAX 02 97980017**

## CONTENTS

<a href="#">Analogue CRT</a> . . . . .	<a href="#">3-2</a>
<a href="#">TV Test</a> . . . . .	<a href="#">3-5</a>
<a href="#">Tripler</a> . . . . .	<a href="#">3-6</a>
<a href="#">Manuals</a> . . . . .	<a href="#">3-8</a>
<a href="#">Rear-Projection</a> . . . . .	<a href="#">3-9</a>
<a href="#">EHT &amp; LOPT</a> . . . . .	<a href="#">3-10</a>
<a href="#">Computer Monitor</a> . . . . .	<a href="#">3-17</a>
<a href="#">LCD TV</a> . . . . .	<a href="#">3-18</a>



**SECTION**

**03**

# TELEVISION PARTS

**2009**

Wagner Electronic Services has been supplying accessories to the electronic manufacturing, servicing & installation industry for 25 years !

We supply an extensive and comprehensive range of components for television repair including Tipplers and EHT Transformers



### HIGH VOLTAGE FOCUS RESISTORS

1 WATT, 10KV-DC, 7KV-ACrms  
Available in 150K, 220K, 270K,  
330K, 390K, 470K, 820K, 1M,  
1.2M, 1.5M, 1.8M, 2.2M, 3.3M,  
4.7M, 5.1M, 6.8M, 8.2M, 10M  
**Order as follows:**  
Wattage + FCR + Value  
Eg. 150K would be  
ordered as 1FCR150K

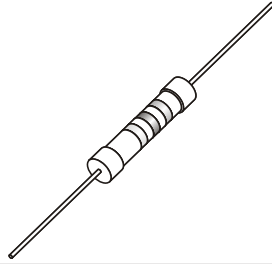

### LUMINANCE DELAY LINE FILTER

Suit many units  
Code DL401P

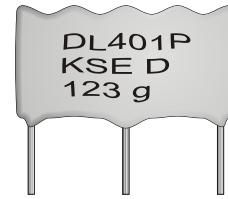

### PHILIPS FOCUS POTENTIOMETERS

24 MegaOhms Suit Philips.  
Three solder terminals  
Orig. 460-900-22  
Code FCP24

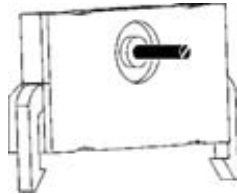

Two contact  
"push-on" type  
Code FCP23

### ANTENNA INPUT PANELS

Both have isolating capacitors.

SINGLE TERMINAL  
Code J515

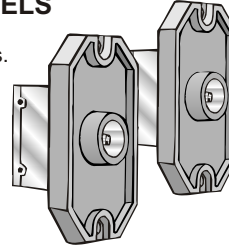

UHF/VHF TERMINAL  
PHILIPS/SHARP/etc...  
Two solder connections  
Code J517

### AC POWER SWITCH POTENTIOMETERS

**NO REMOTE !**  
Volume control with  
pull out two pole switch.  
as used in older TV's.

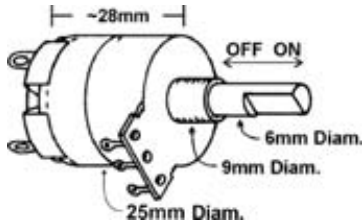

Code. Value. Cost ea.  
VRS105 5k  
VRS120 20k  
VRS150 50k  
VRS100 100k

### ANTENNA INPUT TERMINALS

METAL RF SOCKET  
Code J500

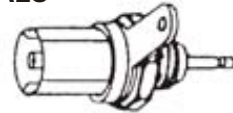

PLASTIC RF SOCKET  
Code J510



**FOR OUR FULL RANGE OF PLUGS & SOCKETS FOR TV SEE SECTION SEVEN**

### HIGH VOLTAGE FOCUS POTS

Code. Value.  
FCP10M 10M  
FCP15M 15M  
FCP22M 22M



### PHILIPS DELAY LINE

Popular Delay Line as used in many TV's.

Equiv DL701  
Code SDL145

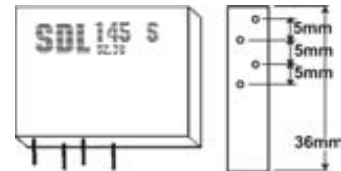

### SANYO FOCUS CONTROLS

Orig. RO116XR  
Code FCP0116

Orig. R0128XR  
Code FCP0128

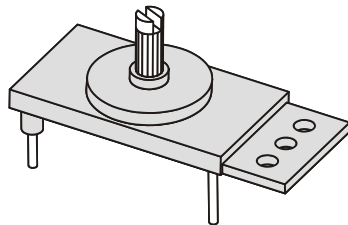

### UNIVERSAL 75Ω VHF-UHF TUNERS

RF SOCKET 8 PIN  
Height 34mm  
Code ECC50

RF SOCKET 8 PIN  
Height 38mm  
Code ECC48

RF SOCKET 8 PIN  
Height 38mm  
\*Socket 12mm  
Code ECC60

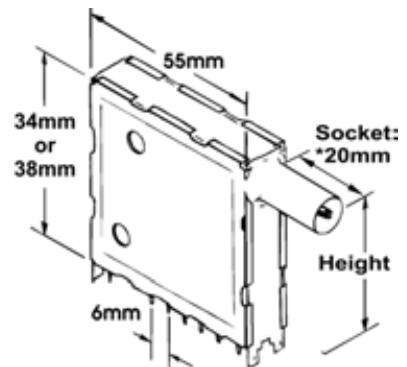

### PHILIPS/KRIESLER CARBON TUNING TRACKS

Code CTR3 3 way  
Code CTR4 4 way



RF SOCKET 9 PIN\*\*  
TECC0985VA14B  
SAMSUNG  
345-197-000-83  
Height 38mm  
Code ECC65

RCA SOCKET 8 PIN  
Height 38mm  
\*Socket 10mm  
Code ECC55





### PHILIPS PTC

Popular 3 pin degauss trigger.

2322 662 96009	265V	6mA	PTC10
2322 662 96011	265V	4mA	PTC14
2322 662 96016	265V	6mA	PTC10
2322 662 96022	265V	1mA	PTC1
2322 662 96101	-	-	PTC12
2322 662 96211	265V	4mA	PTC14
2322 662 98009	265V	6mA	PTC10
2322 662 98018	265V	1mA	PTC1
2322 662 98011	265V	4mA	PTC14

### JVC SWITCH-MODE TRANSFORMER

Suit JVC 7255, 7755 and others.  
Code CE40511

### PHILIPS PTC

4822 1164 0025, 4822 1164 0137,  
2322 6629 6022, 2322 6629 8018,  
96009, 96018, 96022, 96209,  
11164-0137, etc.  
265V 1mA 3-Pin  
Code PTC1

**See Also ABOVE!**  
Similar Style.

### SHARP VARISTOR

Orig. RH-XV0003CEZZ  
Code VX0010

### PTC BLOCK

270V - 15mA  
**2 PIN**  
PTC22

**3 PIN**  
PTC3

**SHARP**  
RMPPT0085CEZZ  
PTC85

**BASE:**  
~18x14mm

### MAGNET CORE INDUCTOR

Horizontal-linearity coil  
Popular TV part used in many models including Akai, NEC, Tempest, Goldstar, etc.  
**20"TV 102µH(0.102mH)**  
Code L102

**14"TV 125µH(0.125mH)**  
Code L125

### PTC POSI-R

PTC Thermistor  
Nichicon Posi-R  
ZPB53-BL200C  
Code PTC20

### TEAC (Vestel) 11AK19 PARTS

Due to design problems with this chassis, HR Diemen has made some improved replacement coil transformers to suit. This applies chassis using the following EHT:

**3000-2055**  
EHT8339  
**3000-2064**  
EHT8029

### SMPS START-UP PTC

Start-up PTC resistor  
Used in TV switchmode  
Samsung, LG, etc.  
P2462-J29, P190,  
1404-000182, etc.  
Code PTC182

### TEAC SWITCH-MODE COIL

Chassis: 11AK19 (Vestel)  
**East/West Coil**  
Orig. 4014100018  
4014100020  
30002026  
Code HR15028

### 63V NON POLARISED (NP)

**BI-POLAR TV Deflection Caps**  
High Current. High-Frequency.  
For more capacitors, see section 2.

Code	Value	Volts	Size
2.2BP63	2.2µF	63V	13x25mm
3.3BP63	3.3µF	63V	16x25mm
4.7BP63	4.7µF	63V	16x32mm
6.8BP63	6.8µF	63V	16x36mm
10BP63	10µF	63V	18x36mm
15BP63	15µF	63V	18x41mm

### TEAC SWITCH-MODE TX

Chassis: 11AK19 (Vestel)  
**Power Transformer**  
Orig. 40326-92  
10524150  
30002080  
4041800110  
Code HR9883



### 8 WAY TUNING BLOCK

28 Pin B20K  
Code VRB810

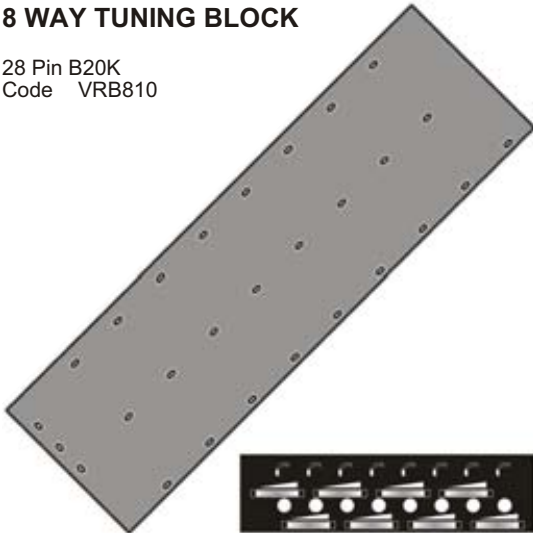

### PICTURE TUBE SOCKET

8 Pins  
including focus.  
Code CRT25

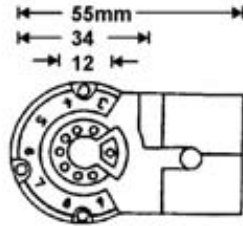

### PICTURE TUBE SOCKET

10 Pins  
including focus.  
Code CRT12

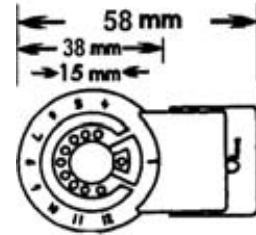

### SONY TV TUNING BLOCK

8 Way 29 Pin  
B100K  
Code VRB820

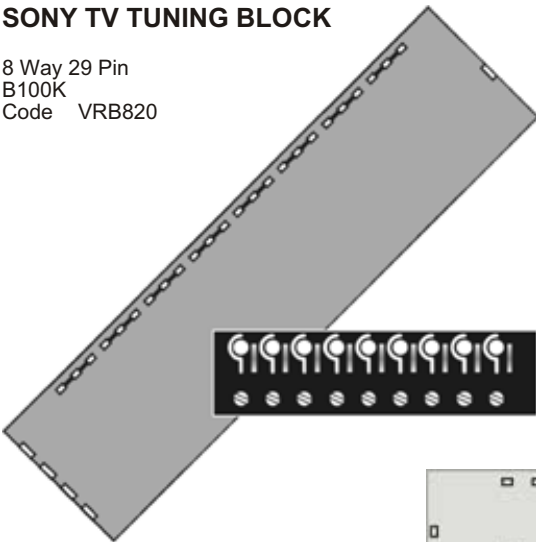

### DEFLECTION YOKES

Original part numbers and models are listed, however these Yokes will substitute many makes and models. "Spec." is the DC resistance measurement of the Vertical and Horizontal coils.



#### 14" TUBE TYPES:

#### DIE1492HL or TCY120PPF (neck=30mm)

Suit C38 Chassis P50F, P54S, CB336F/R, CTK115,143, TE14F/R, 140E7A, 144E8A,  
Spec. H2Ω / V15.5Ω  
Code DIE1492HL

#### ODYM1401 (neck=24mm)

Suit TE14FC, RC, RM  
Spec. H4Ω / V15Ω  
Code ODYM1401



#### DSE1422FL (neck=24mm)

Suit CB3351/A/FA/XU, CB3373Z1A, CTK118, 147, 1430, SP34RM, TV346, TVCR344, 346, NEC N3452.  
Spec. H4Ω / V14.5Ω  
Code DSE1422FL

#### 20" TUBE TYPES:

#### ODYM2002 (neck=24mm)

Suit TE20R/RM/RMT  
NEC N4830, N4840, etc.  
Spec. H3Ω / V14.5Ω  
Code ODYM2002

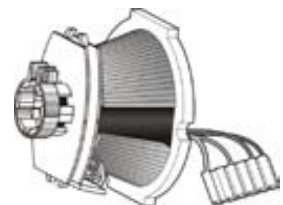

#### ODYM2007 (neck=24mm)

Use ODYM2002  
Re-use the ODYM2007 connector.

#### DIE1992GL (neck=29mm)

32439030010  
Suit CB514H, TE20F, CTK202,  
Spec. H2Ω / V14Ω  
Code DIE1992GL



### 12 WAY TV TUNING BLOCKS

29 PIN B100K  
Code VRB1220

40 PIN B100K  
Code VRB1230

40 PIN B20K  
Vertical label  
Code VRB1240

40 PIN B20K  
Horizontal label  
Code VRB1250





## ISOLATION TRANSFORMER

For safety's sake and to enable the use of instruments such as a CRO, etc.  
**See Section 12**  
 1 AMP TDB240-240



2 AMP TDB240-500

## HDMI TEST PATTERN

[www.cypress.com.tw](http://www.cypress.com.tw)  
 High Definition Generator  
 Repair Plasma and LCD TV  
 35 Timings & 39 patterns  
 HDCP Verification test  
 HDMI Output (only)  
 PC Software intergrated  
 professional unit  
 Code CPHD1



## TV VARIAC

Variable Mains AC Supply  
 "Auto-transformer" type  
 Mechanically adjustable  
 Adjust from 0 to 270VAC  
**Note Not an isolation type transformer!**  
 The neutrals are common,  
 Not for Live TV Chassis.  
 2A VRC2  
 4A VRC4



PICTURE MAY VARY

## VGA ANALOGUE PATTERN GENERATOR

**PC/HDTV Hi-Res Component or RGB**  
 NEW high grade from Cypress.  
 HD15 break-out lead for testing  
 Multi-System TVs, PCs, etc.  
 Compact metal box portable.  
 OSD Menu/Res/Refresh display.  
 27 patterns. RGBVH. YPbPr.  
[www.cypress.com.tw](http://www.cypress.com.tw)  
 Code CPA1

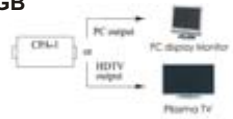

## CRT DEGAUSSING WAND

This powerful wand does the job right the first time, every time.  
 Manufactured in Australia, it plugs straight into 240V.



Code XT8150

## DVI DIGITAL PATTERN GENERATOR

**PC/HDTV Hi-Res DVI-I**  
 NEW high grade from Cypress.  
 29 Pin D shell connector  
 Multi-System TVs, PCs, etc.  
 Compact metal box portable.  
 OSD Menu/Res/Refresh display.  
 27 patterns. RGBVH type DVI  
[www.cypress.com.tw](http://www.cypress.com.tw)  
 Code CPA2

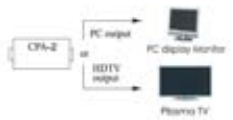

## TV TEST INSTRUMENTS

We have a range of picture tube testers, rejuvenators and colour pattern generators for television repair.



SECTION 14

REPAIR TOOLS & TEST EQUIPMENT

**See Section 14**  
 LOPT, Remote, Thyristor, and HV testers all found in section 14 (Tools).

## TV PATTERN GENERATORS

See Section 14 for a selection of TV test equipment.

Economy AV & RF out with staircase, red crosshatch outputs digital precision.  
 Code CG200P



## REMOTES FOR TV

**Suit TEAC TVR1400**  
 Code REM1400  
**Suit TEAC TVR2000-TXT**  
 Code REM2001  
**Suit TEAC TVR2000**  
 Code REM2000



SECTION 20

See Section 20 For More Remotes!

## TV ANALOGUE PATTERN GENERATOR

**COMPONENT / S-VIDEO / 4:**  
 NEW high grade from Cypress  
 Component, Composite & SVI outputs for testing todays multi-system TVs, VCRs, etc.  
 Moving white block for testing motion jitters, recording, etc.  
[www.cypress.com.tw](http://www.cypress.com.tw)  
 Code LPM-55



OVER 100 PATTERNS

## REPAIR ASSISTANCE?

Surfing for TV Repair information?  
[www.ceta.org.au](http://www.ceta.org.au) Service association  
[www.esca.asn.au](http://www.esca.asn.au) Service association  
[www.diemen.es](http://www.diemen.es) TV/LCD Parts  
[www.eca.de](http://www.eca.de) Semiconductors  
[www.datasheetcatalog.com](http://www.datasheetcatalog.com) Semiconductors  
[www.alldatasheet.com](http://www.alldatasheet.com) Semiconductors  
[www.eserviceinfo.com](http://www.eserviceinfo.com) Service manuals  
[www.cedia.com.au](http://www.cedia.com.au) Installers association  
[www.wescomponents.com/datasheets/](http://www.wescomponents.com/datasheets/)



## TV ANALOGUE PATTERN GENERATOR

**WIDE SCREEN OR 4:3**  
 Promax premium equipment  
 Multi-System Colour out  
 Composite or RGB SCART  
**RF Output 37 → 865MHz**  
 Sound and Video Signal  
 Offers true professional quality from [www.promax.es](http://www.promax.es)  
 Code GV198





### PHILIPS/ERO EHT TRIPLER

BG1895-641-444/LK/etc.  
TVK76, 13-2057, etc.  
Lead 900mm  
Replacement type.  
**DAICHI**  
Code TRP4006

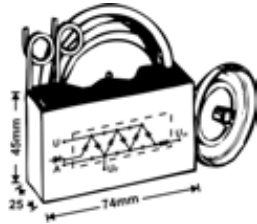

### GRUNDIG / BLAUPUNKT

8-669-433-072  
8-324-800-040  
9546146-02  
BG2087-642-1006G  
HR906-02.03  
TCI 196S6154M473  
Code HRT906



### TRIPLER EUROPEAN

GP Replacement  
for European TV  
Suit HRT227BP  
TVK196-27  
BG2097  
and more...  
Code HRT227

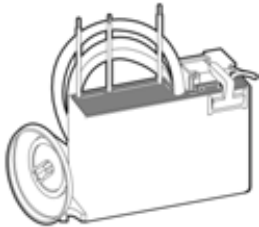

### BLAUPUNKT TRIPLER

BG2087-642-1010G  
Code HRT910

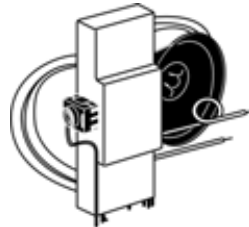

### PHILIPS EHT

Orig. BG2000-641  
Upp 8K6V  
UH 25KV  
MEHR 3.5mA  
RI 500KΩ  
Lead 900mm  
Code HRT209



### BLAUPUNKT

Orig. 8-669-435-416  
8-324-800-045  
BG2087-642-1011  
UH 25KV  
Ri 500KΩ  
VF 7.0-8.6KV  
Lead 600mm  
Code HRT911



### PHILIPS TRIPLER

BG-1897-642-001  
HRT242BP  
Code TRP242



### RANK REPLACEMENT

Suits all early  
Rank televisions  
Code TRP4041

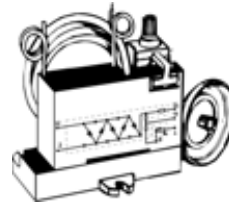

### GRUNDIG SIEMENS BLAUPUNKT SABA

P/No. BG2023-641-3202  
8324-800-034  
75-6820  
Code HRT250

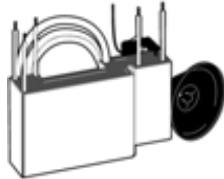

### SANYO TRIPLER

Code Z0047

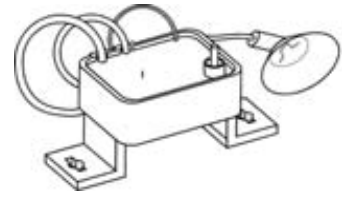

### GRUNDIG TRIPLER

BG2034-642-320  
Suit ST72-172  
Code HRT402

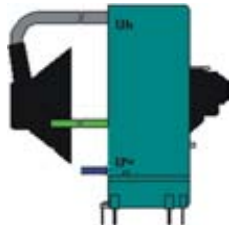

### TELEVISION L.O.P.T TESTER

This handy instrument will simulate the horizontal output of a TV (or Monitor version) to accurately test your LOPT or Diode Split Flyback Transformer. Connect the two leads to the primary, and monitoring the HV lead output, gives you a reading in Kilo-Volts. An LED will alert you to any problem and a fault code will appear on the display to confirm your diagnosis. A fully professional unit from Diemen.



TV STVDST01  
Monitor SMONDST32



### BLAUPUNKT / GRUNDIG

BG2032-642-3201  
8-324-800-036  
8-669-435-422  
Code TRP4043

BG2032-642-3001  
8-669-435-432  
Suit M70-590/9  
Code TRP4048

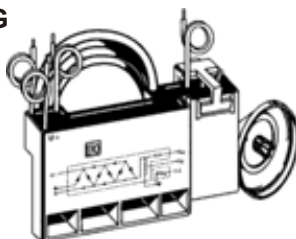



### IBM 3179 HIGH VOLTAGE LEAD

Common fault in this model of IBM monitor.  
 COD-011 with divider.  
 IBM 3179, etc.  
 P/No. 6405282  
 HR1697  
 HR 9R1 1697  
 Diemen 99 46 10  
 Code HV3179



### 12V TV POWER BLOCK

V Regulator for low voltage 10" TVs  
 eg. Tempest TE10RM  
 AKAI, PYE, Rover, etc.  
 Code BL2710  
 or BL2711



Suggest replacing C416,  
 100TKR63 (ea.) too!

### LOPT & EHT HIGH-VOLTAGE LEADS

SEE NEXT PAGES FOR LOPT

*Please Note:*  
 Some LOPTs have detachable leads and are therefore supplied without them. You may re-use the original or you may need to replace it separately.



### SAMSUNG TV TDA3654 KIT

**Premature Failure Of Chip In Power Supply!**

Problem caused by excessive heat. This kit includes instructions, Chip & heatsink to fix.  
 P/No KIT-TVHSINK-1  
 Code TDA3654KIT

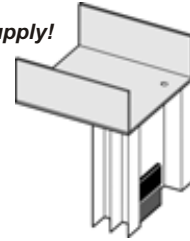

**!! Requires Silicone Heat Compound - NOT Supplied !!**

### HV LEAD SHIELDED

*Please Note:*  
 Some LOPTs have detachable leads and are therefore supplied without them. You may re-use the original or you may need to replace it separately.



Popular Philips type.  
 1M Shielded braid  
 Snap fit LOPT end.

WITH 5mm TIP  
 Code HV1681

### SAMSUNG SMR40200C OR HIS0169B

**Fault in Switch Mode Power Supply.**

When replacing one, the other will blow!  
 Kit CTV0034A-101297  
 P/No. KIT-TVSMPS-1  
 31122-0027-000, 3H83-00820-003,  
 A4010-0090.  
 Chassis P1B Pre 8/96  
 Suit TV346, 486, 516, 4861, 5161.  
 Code SMR40200KIT



### HOZKIT SAMSUNG/AKAI

**Horizontal Kit**  
 A cap, resistor and inductor.

Suit CB515F, Z,  
 CTK108, 143,  
 CTK202, 207,  
 Code HOZKIT



### HV LEAD GENERAL PURPOSE

*Please Note:*  
 Some LOPTs have detachable leads and are therefore supplied without them. You may re-use the original or you may need to replace it separately.



As used in many Asian TVs and HR-Diemens LOPTs.  
 Solid core tip for snap-fit or soldering.

Suit HR-52  
 4136  
 COD-008  
 Length 50cm.  
**SOLDER WIRE**  
 Code HV1663

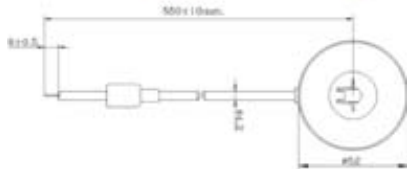

### PHILIPS SOPS REPAIR KIT

4822 310 20489  
 Power supply parts OEM,  
 27x OEM Parts including  
 Surface mount components.  
 KIT SBC7020  
 Suit G110 Chassis  
 Code KIT489



### SHARP TV X0308 POWER SUPPLY CHIP

**Premature Failure Of Chip In Power Supply!**

Changing values of the surrounding components for more reliable service. Kit includes instructions and all required parts.  
 Code X0308-KIT



**CHIP AVAILABLE SEPARATELY**  
 Original X0308-O  
 Substitute X0308-CE



### TEMPEST / PALSONIC / MASUDA KNOB SET

Power knob, etc,  
Suit TE1400.  
Code KNB1400

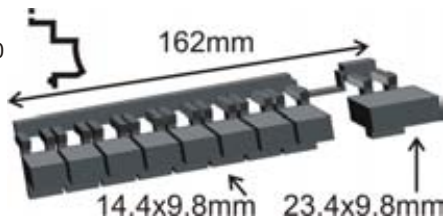

### LCD INVERTER BOARDS

#### REPAIR PARTS

To many to list here!  
New range is expanding  
Download the catalogue  
or Look up the website  
Then contact us for  
Price & Availability

[www.wescomponents.com/hr/](http://www.wescomponents.com/hr/)



### DOOR LOCKS

As used in TV, CD and other applications.  
Code DL1902

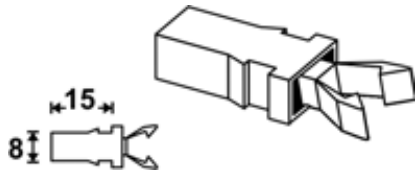

### LOPT & EHT LISTING

#### GET THE BOOK!

A complete listing of  
Diemen LOPT & EHTs.  
Extra info to assist  
you in many areas of  
LOPT part replacement.  
Code DIEMEN Free

[www.wescomponents.com/hr/](http://www.wescomponents.com/hr/)



### LCD BACK LIGHT TESTER

#### CCFL LAMP FAULT FINDER

Test and analyser for panel  
mounted fluoro lamps without  
need for dismantling the  
entire panel. Quick.  
[www.hrdiemen.es](http://www.hrdiemen.es)  
Code TL1040



### DIGITAL TV REFERENCE MANUAL

#### ECONOMICAL EDUCATION

Latest on the current system.  
COFDM, MPEG encoding / decoding,  
Satellite dish, set top boxes,  
digital reception, IRD, STB,  
Glossaries, plus much more!  
Written for the technician.  
Rod Humphris & Joe Aprile.  
Code MANDTV



### HIGH-VOLTAGE PROBE

Measures the High Voltage  
circuits of TV tubes.  
Essential for repair.  
Extra safe protection  
1GΩ. 40KVp-p. ±2%  
Code HV40



### TV DEFLECTION CIRCUITS

Written by Rod Humphris of RMIT.  
150 page, comprehensive reference  
for the repair of high voltage  
circuits in TV, Monitors, etc.  
Excellent source of information  
for techs' new to the field or  
for hardened experts who need to  
keep up with changing technology!  
Code MANDEF



For Info See Section 14

### DOW CORNING SILASTIC

Original silicone elastomer for high  
voltage insulating. Non corrosive & cure  
to a tough, rubbery solid, 90ml tubes.  
Code SIL738



### TV FAULT CURES - UPDATED ANNUALLY

**UPDATED IKON IMAGES.** Australian.  
Logical, concise layout with thousands of  
cures listed. Ideal benchtop companion.  
Some chassis layouts illustrated to help  
you find your way around. Helpful tips  
for component substitution possibilities  
and use of WES code numbers for quicker  
parts ordering and identification.  
Chassis / Model cross reference tables.  
Covers 7000 old and new model TVs.  
Clear descriptions and easy to search.  
Up to date fault & cure listing. Years of  
experience available at your finger tips.  
Improve your workshop output today!



### SILICONE GREASE COMPOUND

Highest quality electrical  
insulator, moisture repeller.  
Eliminate HV tracking.  
Lubricate joints, etc.  
Non-toxic MIL-1-8660B.  
eg. Car ignition switches,  
HV pix tube connections, etc.  
CODE SCO35SL



#### PAPER VERSION

Code MANTVIKON

#### CD-ROM VERSION

Includes VCR-Cures.  
Code IKON-CDR



FOR MORE - SEE SECTION 14



**NEW! REAR-PROJECTION TELEVISION**

**& LCD/LDP PROJECTOR PARTS**

Samsung and other brands.  
 More: Please Enquire!

Send your New Item  
 Suggestions to  
 Att: Product Manager.



**ETHYLENE GLYCOL COOLANT**

**OPTICAL GRADE PROJECTION TV  
 HEAT TRANSFER FLUID 500mL**  
 Suits Sony, Philips, etc.  
 With application syringe.  
 A Half Liter bottle of  
 premium grade solution.  
 500ml EGC500



**LAMP SONY**

**ORIGINAL SONY OEM**  
 Original Sony OEM Part  
 Complete Projector Lamp  
 for a Sony Mobile Unit  
 Suit VPL-ES2  
 Code LMPE150



**SAMSUNG COOLANT SEAL**

48mmØ Spacer Cap  
 Rubber Synthetic  
 OEM BP60-00050A  
 Code SPC50



**LAMP LG**

**OEM LAMP & REFLECTOR**  
 LDP & LCD Zeneth  
 6912B-22002C  
 4930V00301  
 DT-62SZ71DB  
 RT-44SZ60DB  
 Code RPL2002



**LAMP BALLAST SAMSUNG**

**COMPLETE PCB - NO LAMP SUPPLIED**  
 Suit SP-61L2HX  
 P/No. BP47-00016A  
 Eq. BP47-00009A  
 EUC 120W P/H11  
 9137-007-09205  
 Code BP47-16A



**LAMP LG**

**OEM LAMP & REFLECTOR**  
 Rear projector TV  
 LDP & LCD Zeneth  
 6912B-22007B  
 3141VSNH19C  
 52SZ8R-TB  
 Code RPL2007B



**LAMP BALLAST SAMSUNG**

**COMPLETE PCB - NO LAMP SUPPLIED**  
 Suit SP-46L5HX, SP-50L2HX  
 P/No. BP47-00008A  
 Eq. BP47-00002A  
 EUC 100W P/H00  
 9137-007-04005  
 Code BP47-08A



**OIL CLIP HOLDER PACK**

**SAMSUNG REAR PROJECTION**  
 P/No. AA91-00607A  
 Suit SP43J5HF  
 Code AHP607



**LAMP SAMSUNG**

**LAMP ASSEMBLY OEM**  
 Mercury Globe and  
 Reflector assembly  
 Suit SP-403JHP  
 P/No. AA47-10001B  
 160V 100W 1300mA  
 Code AA47-01B



**SPONGE SPACER**

**SAMSUNG DUST COVER**  
 Suits SP42W5HP  
 SP43T5HP  
 SP43T6HFS  
 SP43T6HP  
 OEM AA60-00072B  
 Code SPC72

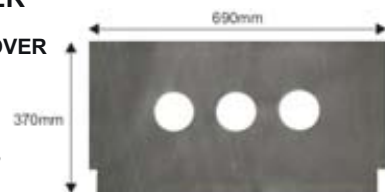

**LAMP SAMSUNG**

**LAMP ASSEMBLY OEM**  
 Globe & reflector assembly.  
 Suit SP-46L5HX, 50L5HX, 61L5HX  
 P/No. BP96-00271  
 Eq. BP96-00271B, C  
 160V 100W 1300mA  
 Code RPL271



**EHT TRANSFORMERS & HIGH VOLTAGE UNITS FOR TELEVISION**

CODE                      DETAILS

**AKAI KONWA**

EHT182	CTK146 CF0304 101-2140-1703 & HR7491
EHT183	CTK206 CF0301 101-2200-0503A
EHT285	CTK115 CTK202 (20") FCM2015AL
EHT6182	CT2570 4515 0344
EHT6160	CT2869 4515 0378
EHT7737	CT1405A FCK14A028 K9615
EHT8183	CT2568AT CT2868AT 101-228002-06
EHT8121	CT2567AT TLF70238 HR8121
EHT7920	CTK280 101-226003-01A TLF70177A (CTK280 had two chassis)
EHT8573	CTK280 CT2867AT 101-226002-01 101-226003-06 101-226006-03 (CTK280 had two chassis)

See Also Samsung, Goldstar, Daewoo & Vision1 →

**AIKO - DAEWOO - NEC - TEMPEST - TEAC**

EHT180	Tempest TE10RM etc.. 101-2100-0103
EHT182	Tempest TE34RM CF0304, 101-2140-1703
EHT183	Tempest TE48RM CF0301, 101-2200-0503A
EHT184	Tempest TE1400 FCV-1422L01
EHT188	Tempest TE34RM FC-1445, KFS60893
EHT190	Tempest SP48RM SP20RMT KFS60506B
EHT191	Tempest SP1400R AIKO ATV3414 BSC222952 13/23V01G
EHT280	14" TV, CB336, CB339K, TE14F FCM1415AL
EHT301	TEMPEST SP5997RM FCR29A015
EHT302	AIKO SC451ME, NEC N1441 and equivalents. DCF-1551
EHT315	AWA C3425 (C43M) NEC N3419 N3420 N3442 14" KFS60226B
EHT305	DCF1577A Suit 14" and equiv. NEC N3441 Tempest TE14FC/RC
EHT304	DCF1577N ** N VERSION OF DCF-1577 **
EHT308	Tempest, NEC, AIKO and others. DCF-2052
EHT310	DCF2077, NEC N4845 C4823 SC2037VR TE20R/RC/RM/RMT 79TD0943
EHT311	DCF2077N, HR7481 NEC DCF-2077N
EHT312	DCF2077A, HR7455 FAT30010
EHT316	NEC N4830/40/46 20" KFS60266/B 79TD0498
EHT317	NEC KFS-60280
EHT497	NEC FS5111 47105367
EHT498	NEC FS6390 FS6395 47105380
EHT499	NEC FS6831 47105384 47105395
EHT501	NEC N4886 47105329
EHT5118	NEC C1816, C2061 4710 5118
EHT5125	NEC 4710, 5123, 5125
EHT6495	NEC C2617,18,35,36,61,70 4710 5125
EHT5180	NEC 47105180 ST2102, ST2103, C1817,C1901,C2026,62,63,71
EHT7651	NEC 47105180 Replacement
EHT5233	NEC 47105233
EHT5402	NEC 47105402 FS5180
EHT5433	NEC 47105433 FS6391 FS6802 MSU1FVK
EHT503	NEC 47105421 FS5185 N4855N
EHT7645	AIKO ATV6800S 154179Z
EHT7865	NEC N3405 47105289
EHT7880	DAEWOO DTC14Q1-TX(&20,21") HST1142.5057 50H0000177 HR7880
EHT7880	TEAC 50H0000152 MV1421 MV1422
EHT7971	AWA 3402AV JF0208-0208.0218,0230, 586530902
EHT7644	DCF2217J HR7644 MV4850 TEAC
EHT7678	NEC 047105198
EHT7927	DAEWOO DT29G1 1352-5008
EHT8007	DAEWOO GREATZ PIONEER 3051504 29P1TL4XT



**AWA - THORN - BAIRD**

EHT195	AWA C617, 618, 619 THORN 9001, 9107, 9138 334B03204/5 & BAIRD 909 and other "K" CHASSIS TYPES.
EHT196	AWA C660, THORN 9405, BAIRD 9201C and 334B04102 & OTHER "N" CHASSIS TYPES.
EHT6070	BAIRD CTS132 AT2070/70A
EHT7026	THORN 22ND5
EHT7806	AWA 4850 HR7806

AWA See also AIKO

**BLAUPUNKT**

See also Grundig

EHT145	HR2458 FAT210-17
EHT5717	IS70-70 29201-025-02
EHT5702	HR5702 FAT3761 MS70-78BVT FM100-40 2920101901/2
EHT6304	8667210473
EHT6311	HR6311 FAT210-311
EHT6321	HR6321 FAT3616 8667210401
EHT6332	HR6332 8667210522
EHT6504	7660530, 7661460/70 IS63-33/51/52 IS70-52

**DIETRON**

EHT7736	KFS60676, DMQ2147
---------	-------------------

**FUJITSU GENERAL**

EHT302	FG1410
EHT6072	11320027
EHT6163	FGS250 472502-00/01 HR6163
EHT6248	FGS282TX 63206300
EHT6271	FGS211B, 251P, 281P, 47272502, 632048000
EHT7273	FCV1010E02
EHT7449	MSH536 GC208
EHT7483	154-165C 591105018A-AA
EHT7484	FG2021 154-177J HR7484
EHT7490	MSH-1FBW24A
EHT7620	FG1441 154-2164A 5908-0512A-AA
EHT7640	MSH1BW03 MSHIFCE01 GC148
EHT7070	HR7070 632045000



**GENESIS**

EHT293 FCR29A006 29" C2901  
 EHT7432 154-277B 20" C2101  
 See also GOLDSTAR & SAMSUNG

**GE - GENERAL ELECTRIC**

EHT5125 C2617, C2618, C2635, C2636, C2661, C2670. 47105125 Orig.  
 EHT6495 47105125 Replacement  
 EHT7261 FCV1410E12A 146P220A  
 EHT7360 104525.30 TX92 Chassis 29GP480 29GS6AH

**GOLDSTAR - ESC - LG - PALSONIC - PRINCESS - TEAC - AKAI**

EHT182 PALSONIC 3438 CF0304 101-2140-1703  
 EHT190 KFS60506B  
 EHT7908 154-168G 154-207E CTK2175  
 EHT320 154-125A 154-132A 14CT9  
 EHT325 154-177B CTM141  
 EHT327 154-194E  
 EHT328 154-189H CTM340-MK2  
 EHT329 154-279C CTM711S  
 EHT330 154-138H BSC231108 KFS60282 HR7679 CTV1466,3455,3458,3488  
 EHT332 154-138P/T BSC25-1102 CF93221 HR7474 CTV4868,4878,4889  
 EHT7432 154-277B Genesis 20" C2101  
 EHT7452 5908-05009A-AA DFN-FC1401 ESC CTV1428  
 EHT7457 154-189C CTM314  
 EHT7462 154-138K HR7462  
 EHT7484 154-177J HR7484  
 EHT7607 154-138N  
 EHT7620 154-2164A FG1441  
 EHT7645 154-179Z ATV6800S CTM715S  
 EHT7666 154-177S CTM205  
 EHT7668 154-125C  
 EHT7673 154-166B 9809-42400 1420/22/23/60 MCH4175  
 EHT7906 154-194D  
 EHT4374 154-374A KFS6114 CT2877  
 EHT7902 154-064J CH14A57 HR7902  
 EHT7910 154-207A KF14μ30  
 EHT7782 FCK14B025 HR7782  
 EHT8029 13420006/0/2/A/B 3000-2064 EU68ST  
 EHT8123 61742-8005E LG CA20F80  
 EHT8562 KFS60490 6128 & 6728  
 EHT8790 40348A-25 EU68ST/1  
 EHT8811 6174Z-6005S CT29Q12IP  
 EHT8905 6174Z-6005U CT29Q24ET  
 EHT30239 LCE-CF122A FAT30239 5908-05016A-AA  
 EHT46165 LG 154-382A



Not here? See also TEAC, SAMSUNG, AIKO, GENESIS...

**GRUNDIG**
**See Also Blaupunkt**

EHT5717 29201-029-02 IS70-70  
 EHT5713 29201-019-10 M70-490/9 FAT30086 HR5713-00  
 EHT6500 29201-029-01  
 EHT6502 29201-029-02  
 EHT6504 29201-029-05  
 EHT6509 29201-029-08  
 EHT6518 29201-030-08 29201-680-03  
 EHT6574 29201-029-052a IS70-35VTM  
 EHT6601 29201-680-01 ST72-261

**HANIMEX**

EHT180 CTV10

**HITACHI**

EHT5191 2435191  
 EHT6114 2433442 T67S51  
 EHT6190 CTP2065 2432611 2432651 HR6190  
 EHT7145 CPT2139 2434596  
 EHT7022 HR7022 2433302  
 EHT7032 HR7032 2434453  
 EHT7041 HR7041 FAT3780 2433521  
 EHT7042 HR7042 FAT3823 309-3147  
 EHT7105 HR7105 2434451  
 EHT7135 HR7135 FAT3973 2433721  
 EHT7136 HR7136 FAT3976 2433301  
 EHT7239 HR7239 2435521 CMT2159  
 EHT7525 HR7525-02 2435192  
 EHT7526 HR7526 2435301  
 EHT7518 HR7518 FAT3835 2434141  
 EHT7557 HR7557 2435501 FM200 PM51-40  
 EHT7730 HR7730 2435066 CL2114R  
 EHT7778 HR7778 2435063  
 EHT7878 CMT2110-194 C2114T

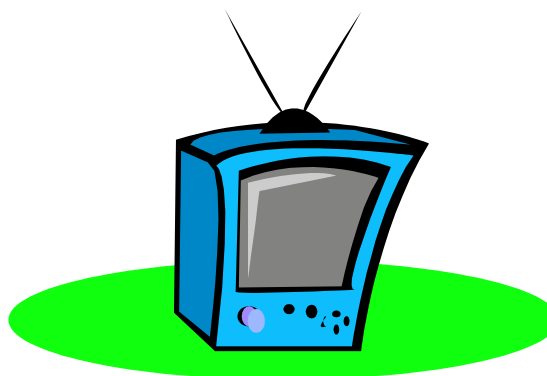
**HITACHI FUJIAN**

EHT2105 BSC21-0526-5731-081A  
 EHT7146 HFC2111B BSC25-0120

**HMV - DECCA - FERGUSON**

EHT10 HR2080-10 FAT080-10 HMV C221, DECCA EZ1012  
 EHT3538 TX100-90° FAT3538 2433892  
 EHT7026 TX100-100° HR7026 FAT3758 HMV-9563, 9653, FERGUSON  
 EHT7156 TX100-90° HR7156 FAT3497 90° FERGUSON

**ITT**

EHT6113 003060104 7262793 4515-03-13/19 D046137

**JVC**

EHT340 P/No. A19170-A replaces A19164A, A191280A  
 EHT6550 AV28S4E AT2077-39  
 EHT8269 AV21-TEAV C.J27898-00AJ1 C.J28069-00AJ1 C.J28069-BJ1

**LOEWE**

EHT6100 D108/37  
 EHT7378 24513.18-5 COMTUR 1270 CHASSIS E3000  
 EHT8421 1372-0016C 1372-0081B 276-27397-050 Suits 5684Z

**MASUDA**

EHT180 T109 & T1092 101-210001-03  
 EHT183 T2091, T2094, CF0301, FCM20A016, 101-220005-03A  
 EHT7444 KFS60506B, K2001, HR7444  
 EHT7918 S21TXS, CF0467

**MITSUBISHI**

EHT370 334B07403  
 EHT373 334B07406  
 EHT376 334B07409  
 EHT379 334B07701  
 EHT382 334B07803  
 EHT7901 334B07901  
 EHT7631 334B08108 CT2553  
 EHT7685 334B08105/0 334P08109/0 CT2153  
 EHT385 334P15308P  
 EHT388 334P15309  
 EHT389 334P22101 CT29ACI

**NAD**

EHT5644 Model 6380, 45150167 HR5644 FAT056-37

**NATIONAL - PANASONIC**

EHT200 TLF14511  
 EHT201 TLF14512  
 EHT4556 TLF14556  
 EHT202 TLF14565  
 EHT207 TLF14650  
 EHT4577 "B" Version TLF14577B  
 EHT7824 "F" Version TLF14577F  
 EHT7801 TLF14595F Replacement  
 EHT205 TLF14676F, TLF14691F  
 EHT206 TLF14695  
 EHT208 TLF14673 TC1450  
 EHT210 TLF14610F  
 EHT211 \*2 VERSIONS\* Suit Remote Types TLF14612B1  
 EHT212 \*2 VERSIONS\* Suit Non Remotes TLF14612B/F  
 EHT213 TLF14736  
 EHT215 TLF14649  
 EHT216 TLF14749  
 EHT217 COIL ONLY SUPPLIED, Must be fitted onto existing TLF6024 ferrite. Tripler is not supplied.  
 EHT218 TLF6031B  
 EHT219 TLF14690F, TLF14675B  
 EHT221 TLF14658B  
 EHT220 TLF14683  
 EHT4699 TLF14699F3  
 EHT7872 TLF15518F Replacement  
 EHT7784 TLF15519F1 Replacement  
 EHT5602 TLF15602F  
 EHT222 TLF6606B  
 EHT224 TLF6609B  
 EHT8335 TLF15538F TC29A4PR/X TCA29 TCAV29CX  
 EHT7714 TLF15562F  
 EHT8264 TLF15626 TC14E1A  
 EHT8398 TLF15566F TX25A3 TX28W3 TX29A3

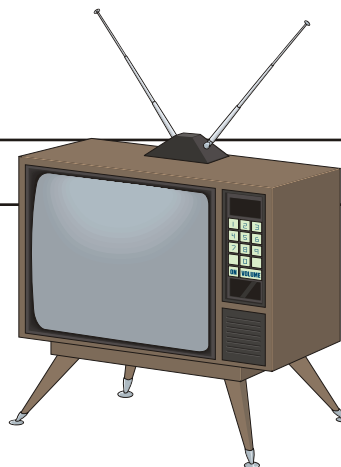
**NOKIA/ITT**

EHT6005 D004-37  
 EHT6057 45150350 NOKIA 5550VT  
 EHT6157 45150340 NOKIA 6380VT  
 EHT6284 45150308 NOKIA C351VT  
 EHT7214 45150503.04,21 NOKIA 7163VT

**NORDMENDE - SABA - THOMPSON**

EHT102 HR2063-00 FAT063-00 10 PIN TYPE Nord.525.235/238/239  
 EHT105 HR2080-00 FAT080-00 11 PIN TYPE Nord. SPECTRA COLOUR  
 EHT6024 HR6024/6036 FAT3664  
 EHT6067 HR6067 FAT3816 NORD./SABA 525-599, THOMPSON 472359  
 EHT6245 HR6245 FAT3846 309311957 473284.00 260813 344TX0238  
 EHT7032 HR7032 FAT3847 NORD.2434453  
 EHT7041 HR7041 FAT3780 THOMPSON TS3617 2433521  
 EHT7042 HR7042 309-3147  
 EHT7126 HR7126 FAT3729 THOMPSON 440760-00  
 EHT7128 40011200 077863222 M5105,5107,5505,5506,5512,5515,5520,5523

**ORION**

EHT6468 HR6468 1182-0997 TRIADE 8603  
 EHT7460 HR7460 371-4002  
 EHT7779 FCM20B043  
 EHT7829 HR7829 322-0016 21ST  
 EHT8416 1352-5006R 34BuB  
 EHT8526 1372.0019 S065624000 28UVA 29DUA T2900 T7800

**PHILCO**

EHT7063 SS2500LXD

**PHILIPS -PYE- KRIESLER**

- EHT20 HR2031-22 4822-140-10138, FAT10-138 K9, 59-01, 59-02 CHASSIS
- EHT30 HR2045 4822-140-10145, FAT10-145 K11, 59-03, 59-05 CHASSIS
- EHT40 HR1490 4822-140-10149, FAT10-149 KT2A-2/3, 20A-17, T36
- EHT45 4822-140-10176,10178, FAT10-176 KT3 KT3A KL9A-2/3 T38 T39
- EHT46 HR1610 FAT10-161 KT3A-2S 9 PIN
- EHT50 HR2176 PHILIPS KL9A/A1 etc. PYE T39
- EHT60 HR1492 4802-140-17097 KRIESLER 59-04
- EHT180 PYE PY101PC
- EHT260 4802-140-17057 PYE 14G4, KRIESLER 37-104
- EHT265 4802-140-17101 PYE (Original Sharp)
- EHT7050 4802-140-17101 PYE (Replacement)
- EHT129 4802-401-7129 14017129 FCC120 28CE1965
- EHT294 PYE PY1401RC
- EHT2101 20GR1365, AT2101/01, /02, AT2102/02A, 4822-140-1379
- EHT7500 4822-140-10352, 21CN4060-75 NCF TXT
- EHT6040 4822-140-10246, K40 MatchLine 26"
- EHT6094 4822-140-10247, KT4 MatchLine 22"
- EHT6012 HR6012 4802-140-10151,17073 FAT10-151, K12, T37, T38  
(Note: You may need a HV Lead with the above: Code HV4841 )
- EHT7860 4822-140-10506, -10511, 2422-531-02132, BSC25-6001, 21GX, 25GX
- EHT6096 36511 KT2260 KT2036 KT2226 KT2236 KT2636
- EHT6098 HR6098 CTXA1S, CTXA2S 4822-140-10198, 10395
- EHT6133 HR6133 FAT3832 PHILIPS CTO-S 4822-140-10254
- EHT6140 4822-140-10294 HR6140-04 Konig FAT3820 Chassis 2BS Replacement Type (Recommended)
- EHT6141 HR6141 36832 22CE 2061/05T
- EHT6206 HR6206 4822-140-10386, G110-PTV
- EHT6213 HR6213 4822-140-10384, 10398 G90, G110-Euro  
& AT2077-88E, 157-53862, 25GR97601308
- EHT6214 4822-140-10325, 4812-140-10325, AT2077/88, 25CG6270, CP110
- EHT6216 4822-140-10378, 28DC2070, 37971
- EHT6265 HR6265 AT2077-32
- EHT6467 HR6467 AT2077-85A
- EHT6478 HR6478 4822-140-10407, 10382 G110-S G111-E G111-S G112
- EHT6581 HR6581 4822-140-10408, 3122-1383-8140/1/2/3/4
- EHT6483 HR6483 4822-140-10414
- EHT6484 HR6484 4822-140-10399 28GR9770/28B
- EHT6489 HR6489 4822-310-31892, 4812-140-10275, 4822-140-10275
- EHT6535 HR6535 4822-140-10431, 4822-140-10429, MARK2
- EHT6547 HR6547 4822-140-10424, FL101, 33ML8990/6
- EHT6549 HR6549 3122-1383-8220, AT2077/38
- EHT7503 PHILILTA 15CE1210/22B, Chassis 30326, ARISTONA 43KE1315
- EHT7505 4802-705-17151, 4822-140-10282, 10326, FAT3819, CF1, 36692
- EHT7506 HR7506-01, 4822-140-10349
- EHT7519 HR7519, 23236052
- EHT7524 HR7524, 4822-140-35353, 35356 21GR9650, 21GR9750, G90B
- EHT7525 HR7525, HR7525-02, 4822-140-10338, 140-20068, 10338, NCF-CR
- EHT7526 HR7526, 30370, 36943/4
- EHT7527 HR7527, 4822-140-10369, -10379, Philips-3762, GR1-AX
- EHT7541 HR7541, AT2079/18
- EHT7564 4822-140-10328 NC3-CR-S NCF SV00 8801
- EHT7678 459700 47105198
- EHT7789 20GX8350 1142-5020 4822-146-21116 4822-140-10525
- EHT7980 4822-140-10548 2422-531-02149 29GX1891, 1893, 1896
- EHT7815 4822-140-10557
- EHT7936 HR7936 AT2090/18
- EHT7963 4822-140-10612 14PT138A 20PT1482 HR7963
- EHT8124 4822-140-10637, 21PT2622/75
- EHT8291 OV 2076-20593 34PT5793
- EHT8329 MCS Cassis AT207820671 21HT1582 21PT3722, 434, 534
- EHT8304 4822-140-569 21PT238 hr8304
- EHT8318 2443-6994 21GX1566
- EHT8331 OV 2076-21041 29PT6021 29PT6361
- EHT8333 4806-140-10649, 17077 1372-0001, 0011 2422-531-02282
- EHT8370 1352-0003 25PT468A/75R
- EHT8380 4822-140-10666 29PT4273 29PT4873
- EHT8707 4822-140-10629 1302-0009 29PT886A
- EHT8809 4822-146-10961 29PT4673 29PT4473 AT2079/BO HR8380
- EHT17003 26CE1991 FCC096 VE8103-4 4802-142-17003



**RCA**

- EHT8317 10566060-P2 1532873A 29DH91A
- EHT8314 40337-14 R21GG8RA

**EHT LOPT not listed ?  
Track it down with Diemen !**

**Contact us with order details  
Diemens is the Largest source  
of LOPT/EHT in the world !**

**VISIT [http:// www.hrdiemen.es](http://www.hrdiemen.es)  
or Get the FREE Catalogue (Code DIEMAN )**

**SAMSUNG - AKAI - PRINCESS - GAF - EXPO - TEMPEST**

EHT278 FCC-1415AL HR7254 MHF042-01A  
 EHT279 FCK-1415AL  
 EHT280 CB3312Z,CB5025J,CB3325J,CB3412, 14CT6,PF1 TLF770018  
 EHT7852 CB3351 TVCR344 TFK14A004P  
 EHT7623 FCR25A003 32859-200-004 CB5913, CB5915, CB6813WT  
 EHT289 CB230/Z SP25987/RM 30E91-5085 FC31A04 KFS61416 TCG20B02  
 EHT291 AA26-30001F FCG-2012L06 CB5330WT  
 EHT299 AA26-30001P FCR25A009R TV595  
 EHT297 AA26-30001Y FSV20A001 CB3373,5073 TV346,486,487,516,517, SCT11B P1B etc.  
 EHT301 FCR29A015  
 EHT7623 FCR25A003 Replacement  
 EHT283 FCR25A006R CDX2512 CDX2514 KH25  
 EHT7680 FCR25A005 32859-200-013 CB6230WT  
 EHT285 20" TV, CB514, CB515, TE20F, CB5012Z FCM2015AL CB5023J, CB5023Z, etc.  
 EHT286 FCG1445EL CTK110,115,145,161 CB3310  
 EHT7853 FCG2012L06  
 EHT287 FCG2045 CTK211T  
 EHT288 FCG2045BL CB348,528,542 CTK203 P54S  
 EHT7834 FCK14A019A CT1407  
 EHT7843 FCK14A033 A1201-0047  
 EHT7617 FCM20A023 CB53187  
 EHT7929 FCM2015HE OKI-532 HR7902  
 EHT7605 FCM2015ML CW5029  
 EHT7618 FCM1411-01 2859154052 32859154052  
 EHT290 FCR2615AL CB667  
 EHT293 FCR29A006 C2901 29"  
 EHT296 FCM20A015 CB5051,5312,5322,5324, P58SC RM109 TV484R1 TV514  
 EHT297 FSV20A001 P1B SCT11B TV4861 TV5161  
 EHT298 FSV20B001 CS5377W SCT12A  
 EHT7852 FTK14A004P  
 EHT292 FTK20R002 TVCR514  
 EHT7432 FCM20B022 154-277B  
 EHT7680 FCR25A005 32859200013 CB6230WT  
 EHT7908 CTK2175, 154207E  
 EHT7614 FCR29A014R AA26-30001M TV685 TV686-(See EHT7968 too)  
 EHT7968 FTH29A001 TV686 (Beware! 2 Chassis this model)  
 EHT7955 AA26-30001K CB6330Z CDX2512 CDX2514 KH25  
 EHT8093 AA26-30002W TV686  
 EHT8854 AA26-30002P FCZ29A002 CS7277PF



**SANYO**

EHT61 610-017-8991 FD0039 CPP3005-VR00 CPP3033-00  
 EHT63 CPP6101VBT FD0003  
 EHT64 FD0034  
 EHT66 FD0024  
 EHT72 FD0187 FD187 610-207-8022  
 EHT65 HR3606 FO210 (Not "A")  
 EHT79 HR3607 FAT3712 FO227 CTP7605/7/8  
 EHT80 HR3608 FAT3713 FO234 or FO210A ("A" Only!)  
 EHT85 610-018-6286 F1111  
 EHT88 610-018-6309 F1113  
 EHT90 F1141  
 EHT1250 FD0125 CCP3002  
 EHT6143 F1143  
 EHT6267 F1143A CTP6190,6210,6226,6238,6281,6631  
 EHT6482 610-018-6859 F1162  
 EHT7627 FD0199 HR7627



**SCHNEIDER**

EHT8431 1372-6009A 3210  
 EHT8620 1372-0033 FAT30717 2810

**LOPT/EHT Not Listed? "The Book!"**

**"The WEB"**

**Check out**

**your**

**Diemen Resources**



[www.hrdiemen.es](http://www.hrdiemen.es)

**SHARP**

- EHT229 RTRNF0027 CX3448W CX3469 CX3479
- EHT7675 RTRNF0027 Replacement
- EHT235 RTRNF0063 CX34A1 CX34A3
- EHT7711 RTRNF0069 CX51B2 CX51B4 VT5128X Replacement
- EHT260 RTRNF1154 14G4 37-104 37-133 5907 9C145
- EHT6396 RTRNF1182 CX2010 CX2020 CX2031 CX2071 Replacement
- EHT1205 RTRNF1205 CX2220 CX2270
- EHT1210 RTRNF1210 CX1881
- EHT265 RTRNF1220 CX1461 CX1481 34PT2
- EHT7050 RTRNF1220 CX1461 CX1481 34PT2 Replacement
- EHT263 RTRNF1247 CX2032 CX2072 CX2073 CX2082 CX2232
- EHT263 RTRNF1257 CX2232 CX2272 F1257CE
- EHT7348 RTRNF1257 CX2232 CX2272 F1257CE Replacement
- EHT266 RTRNF1261 CX1482 DV1400X
- EHT240 RTRNF1287 DV1600
- EHT244 RTRNF1318 CX2033 CX2074 CX2083 DV2095 DV4884
- EHT1349 RTRNF1349 CX2273
- EHT6610 RTRNF1366 CX6374 CX6375 DV2695 DV6384 Replacement
- EHT1382 RTRNF1382 CX4814 CX4834 CX4844 LX4814
- EHT250 RTRNF1412 CX3434 CX3465D
- EHT7753 RTRNF1412 CX3434 CX3465D Replacement
- EHT270 RTRNF1442 CX3436 CX3466
- EHT268 RTRNF1580
- EHT7790 RTRNF1625 CX6336 CX6337 CX6366 CX6376 CX6376A CX6378 CX6379 DV6386 Replacement
- EHT270 RTRNF1630 CX3436S
- EHT272 RTRNF1687 CX3437 CX3447 CX3467 CX3478
- EHT7773 RTRNF1687 CX3437 CX3447 CX3467 CX3478 Replacement
- EHT7748 RTRNF1689 Replacement
- EHT273 RTRNF1691 CX2048 CX2078 CX4838 CX4847
- EHT7758 RTRNF1717 SV2878 SV2878NZOS
- EHT274 RTRNF1751 CX3451
- EHT7732 RTRNF1780 CX6349 CX6352 CX6359 CX6362 DV6389 DV6686 DV6389 Replacement
- EHT6167 RTRNF1783
- EHT7870 RTRNF1856
- EHT6256 RTRNF2000 SV6689X
- EHT7531 RTRNF2006BM XV6689X
- EHT8815 RTRNF1754 33S21A/1/S DV7988X SV3320H
- EHT8816 RTRNF0045 CX5151



**SONY**

- EHT6400 1-439-332-00/11/21 KV2764
- EHT6401 HR6401 1-439-332-31
- EHT6402 HR6402 FAT3925 1-439-332-41
- EHT6403 HR6403 1-439-332-42
- EHT6405 HR6405 FAT3932 1-439-288-00/12
- EHT6407 HR6407 FAT3913 1-439-280-00/13
- EHT6408 HR6408 FAT3918 1-439-303-00/11/31/32
- EHT6409 HR6409 FAT3910 1-439-244-00/11/21/31
- EHT6410 HR6410 1-439-243-11
- EHT6412 HR6412 1-439-286-00/11/12/13/21 KV2210 to KV2224
- EHT6414 HR6414 FAT3912 1-439-276-21
- EHT6413 HR6413 1-439-289-00 KV2782
- EHT7243 HR7243 1-439-493-11 KVC293
- EHT7245 HR7245 1-439-423-21/31 KV2183
- EHT7244 HR7244 1-439-416-11/12/21/23/41/51
- EHT7337 HR7337 1-439-423-61/62
- EHT7401 HR7401 1-439-331-41
- EHT7402 HR7402 1-439-387-11/21 KV21XRD
- EHT7403 HR7403 FAT3929 1-439-363-11/21
- EHT7405 HR7405 1-439-294-21
- EHT7406 HR7406 FAT3919 1-439-311-21/22/23
- EHT7407 HR7407 FAT3920 1-439-311-00/11/13/31
- EHT7408 HR7408 FAT3926 1-439-333-00/11/12
- EHT7777 HR7777 1-439-530-21 KV2185
- EHT8569 1-433-307-11 1-453-248-11 1-453-248-21 8-598-994-10
- EHT8575 1-453-219-11 KV-T29SF8
- EHT8577 1-453-284-11 1-453-297-21 8-598-831-01 NX4009 KUX29
- EHT8578 1-453-219-11 8-598-976-00 KVT29-SF1,8
- EHT8580 1-453-326-11 8-598-836-01 KVES34M31
- EHT8662 HR8662 1-453-250-11 8-958-811-00 KVG21S2 KVJ21SZ2
- EHT8807 1-453-180-11 NX-1721-M3A

**EHT LOPT not listed ?**  
Track it down with Diemen ! **DIEMEN** s.a.  
Contact us with order details  
Diemens is the Largest source  
of LOPT/EHT in the world !

VISIT [http:// www.hrdiemen.es](http://www.hrdiemen.es)  
or Get the FREE Catalogue (Code DIEMAN )

"The book" of the Flyback



**TEAC SEE ALSO GOLDSTAR, SAMSUNG, AKAI / KONWA.**

EHT303 CTM342H CF0801-3701 001-214701-13 RMT344  
 EHT80118 CTF683 (See Below) 001-229084-13 CF0801  
 EHT309 CTF683 (See Above) 001-234234-10 JF01011134A  
 EHT319 CTM1401 JF0208-0205 58-63703C-03 BSG2516  
 EHT320 CTM20RC  
 EHT327 CTM145, CTM215  
 EHT328 CTM340 MK2 154-189H  
 EHT30239 CTM28S LCE-CF122A FAT30239 5908-05016A-AA  
 EHT6170 CTM28SRCT HR6170 3243-31692  
 EHT7437 CTM483 FAT30050 KFS60371D 154-177N  
 EHT7438 CTM485, CTM486 FCM20B027  
 EHT7612 CTM48RC PA02404200 HR7612 FCM20B010  
 EHT7464 MV1440 152-591 1810951  
 EHT7666 CTM205  
 EHT7687 MV1480 FCK14B2  
 EHT7691 CTM204 FCM20B031 FCM203034 9A0147100  
 EHT7729 CTM344 FC1434  
 EHT7806 CTM511S 154-277C  
 EHT7834 CT1406 FCK14A019A HR7834  
 EHT7971 CTM1413 JF0208-0208,0218,0230, 586530902  
 EHT7950 EU34HT EU48ST EU51ST 30002051 40337-19  
 EHT7950 EU34T EU34TB 30002050  
 EHT8361 43-74/1402F MV1416P  
 EHT8029 EU68ST 30002064  
 EHT8790 EU68ST1 40348A-25  
 EHT8339 EU80ST 30002055  
 EHT8921 JF0101-0101 CTM596S CTM661R  
 EHT8955 EU684F



**TELEFUNKEN - B & O**

EHT5721 8669435203 MS63-79-VT FAT30323 HR5721  
 EHT6245 309311957 FAT3846 HR6245 472384.00  
 EHT6354 309311979  
 EHT7311 FAT3834 AT110/27/07 AT110/27/17  
 EHT7042 FAT3823 HR7042 309-3147  
 EHT7172 309-3173 243-5671 MP143VTH  
 EHT7274 309-3180 243-5675  
 EHT7302 AT90/25/03 AT90/25/06 Model 1440  
 EHT7303 AT90/25/15F Model 5216  
 EHT7305 AT110/25/01 AT110/25/1000  
 EHT7306 HR7306-01 FAT3688 AT110/26/01 or AT110/26/02  
 EHT7307 AT110/26/15 Model 1590  
 EHT7308 AT110/26/05 HR7308  
 EHT7309 AT110/26/05F AT110/25/05F AT110/25/15F HR7309  
 EHT7317 AT110/27/17 HR7317  
 EHT7320 AT110/27/23 HR7320  
 EHT7321 AT110/25/22 HR7321  
 EHT7360 TX92 & TX29F Chassis DS297AHX



**TOSHIBA**

EHT280 140E7A FCM1415AL  
 EHT285 200E7A/R7A FCM2015AL  
 EHT4012 TFB4012AD  
 EHT4013 TFB4012BD  
 EHT7723 TFB4032AD/BD 158R6A HR7723  
 EHT4038 TFB4038AD  
 EHT7451 TFB4048AD HR7451 187E5A  
 EHT7479 TFB4039AD HR7479 199R4A  
 EHT7519 HR7519 TOSHIBA 14" 23236052  
 EHT7654 22236083 T23236083 TFB4067BD 207E7AK  
 EHT6355 TFB4062AD 3714004 12-Pins  
 EHT7657 TFB4062AD PW5940 289T6B 10-Pins  
 EHT7655 TFB4086AD 289D8A

**VISION ONE**

EHT152 VIS100R DXT717 CF152B  
 EHT294 FCK14A009 VIS146R  
 EHT295 FCM20A021 VIS240R

**LOPT/EHT Not Listed? "The Book!" "The WEB"**

Check out  
 your  
 Diemen Resources



[www.hrdiemen.es](http://www.hrdiemen.es)

**ARCADE MACHINES**

- EHT3060 MSH1F-PU07 5F13060AH1 MS7-20L, ATARI, WELLS-GARDNER, KAGA, NANO
- EHT6209 28028500 HANTAREX POLO-1 25" TO 28"
- EHT7375 28020280 HANTAREX POLO 1/2/28, 25" to 28" 15K/24K
- EHT7717 53X0528-001 WELLS GARDENER U5000, etc.
- EHT46217 KFS61088, TCF8113, KORTEK 25"
- EHT60291 KFS60291, KORTEK 20" VLT

See Also Computer Monitor LOPT Listing Next Page...



**MONITOR COMMODORE/PHILIPS LOPT VARIATIONS**

Please check the following information when ordering:

- EHT7506** P/Nos. 4822 1401 0349, AT2079/30101 and AT2079/30102  
\*8 pins plus focus/screen earth.  
Suit Commodore 1084SP, Mercury Monitors, Philips CM85,87,88,8833.
- EHT7533** P/Nos. 4822 1401 0381, AT2079/37591  
\*7pins plus focus/screen earth  
Suit Commodore 1084SP1, 1084SP1AU, Atari SC1435, Acorn AFK17, Philips CM12
- EHT6489** P/Nos. 4822 1401 0275, 4812 1401 0275, 4822 3103 1892,AT2076/367  
7 pins plus focus/screen earth.  
Suit Commodore 1084AU



**COMPUTER MONITOR LOPT**

- | CODE     | DETAILS  |
|----------|--|
| EHT421   | 3F14001 AMSTRAD  |
| EHT432   | 47F130210 CTX CVP5468, TP250   |
| EHT456   | LCE-CF0456 19-70018-001 LG/GOLDSTAR TOBISHI ACER-7156L   |
| EHT478   | 40111 (440-005-00) LIBERTY 396B2M  |
| EHT482   | 420007-01 WYSE 50 , 80-004-08 ALTOS 3  |
| EHT483   | 429014-06 WYSE 55 , MFB-23/363 E144238 960806  |
| EHT485   | 420016-01 WYSE 60 (TMF2500B)   |
| EHT488   | 420015-01 WYSE 99  |
| EHT495   | 420031-01 WYSE 30  |
| EHT515   | IBM3180, (see above) 74730103437, MAT3038, MD080A, HR46030   |
| EHT568   | MSH1FBU113   |
| EHT605   | TFB4806 FEA306 Pakard Bell 6133048061 078b-01-32   |
| EHT655   | AT2077-80 IBM 3192   |
| EHT659   | AT2077-46R IBM 3192  |
| EHT662   | AT2077-81  |
| EHT3161  | OSBORNE M0215NL/LR 312213830161 AT2090-09 MAT33197   |
| EHT4556  | TLF14556F PANASONIC  |
| EHT6089  | ITT 3786, 45150326   |
| EHT6209  | 28028500 HANTAREX POLO-1 25" TO 28"  |
| EHT6355  | AMSTRAD CTM644   |
| EHT6489  | HR6489, MAT33411, E39144-36731, AT2076/36731<br>& COMMODORE 1084AU 4812-101-0275, 4822-1401-0275, 4822-3103-1892 |
| EHT7041  | HR7041, 2433521 COMMODORE 1901, DTX2001, THOMPSON T55152   |
| EHT7194  | OLIVETTI 28028780  |
| EHT7219  | SELT I SL821432301 12420068  |
| EHT7375  | 2802080 APPOLO 28" HANTAREX POLO-2 25" & 28"   |
| EHT7506  | HR7506, 31380138 30100 COMMODORE 1084SP, MECURY MONITORS   |
| EHT7533  | HR7533 FTR7533 COMMODORE 1084SP1-AU, PHILIPS CM 12 CGA<br>& AT2079-37591, 4822-140-10381                         |
| EHT7564  | HR7564-00, 482214010328  |
| EHT7641  | 4822-140-10487 TLF73523 OSBORNE MPV1024 MSU1FGV29  |
| EHT7647  | IBM3472, 3477, etc. 16F1205 HR7647   |
| EHT7664  | EMC FEA241 LR14 EF836 EF848 730-302-1433   |
| EHT7686  | 7303121424   |
| EHT7693  | HR7693 PHILIPS AT2094-01, AT2090-33, IPC MONITOR   |
| EHT7805  | TLF85686B Industrial Monitor   |
| EHT7706  | AT2090/01 PHILIPS 312213837960   |
| EHT7708  | HR7708 IBM 028002 SERIES PS1, FC014030   |
| EHT7764  | ACER 7134T404, P/No. CF0625  |
| EHT7792  | AT2090/51 PHILIPS OSBORNE MP15DLS  |
| EHT7937  | SAMSUNG HP COMPAQ FUJITSU FT014A041  |
| EHT46093 | IBM 6541-02S TFB4813 SAMPO 9915 FEA507 6133048131  |
| EHT46109 | HR46109 4822-140-10641, AT2090-31, 4CM1770   |
| EHT46117 | SAMSUNG 5E1  |
| EHT46118 | HR46118 4822-140-10641, AT2090-35, C2082DAS  |
| EHT46121 | LG PROVIEW 730-302-0570 FEA708 FSN15b045N  |
| EHT46122 | LG PROVIEW 730-302-564A FEA287 FSN15A008 F/S   |
| EHT46127 | 154-218C/382F 6174Z2001D FMMPC11-2001 ACER DIGITAL LG  |
| EHT46146 | EPSON ELC14VGA MPR2  |
| EHT46148 | GOLDSTAR LG 44 45 55 520 521 550   |
| EHT46159 | GATEWAY GOLDSTAR LG 61747-1012B  |
| EHT46174 | GATEWAY GOLDSTAR LG 61747-1012C  |
| EHT46176 | 6174Z1003G IMAC-233 IMAC-M4984   |
| EHT46187 | GOLDSTAR LG GATEWAY EV500 CB575 SW575M SW575W SW575W   |



[www.wes.net.au](http://www.wes.net.au)[www.wescomponents.com/hr/](http://www.wescomponents.com/hr/)*Other sites of repair assistance:*

[www.ceta.org.au](http://www.ceta.org.au) Service association  
[www.esca.asn.au](http://www.esca.asn.au) Service association  
[www.hrshop.es](http://www.hrshop.es) TV/LCD Parts  
[www.datasheetcatalog.com](http://www.datasheetcatalog.com) Semiconductors  
[www.alldatasheet.com](http://www.alldatasheet.com) Semiconductors  
[www.eserviceinfo.com](http://www.eserviceinfo.com) Service manuals  
[www.cedia.com.au](http://www.cedia.com.au) Installers association  
[www.wescomponents.com/datasheets/](http://www.wescomponents.com/datasheets/)  
[directory.google.com/Top/Science/Technology/Electronics/](http://directory.google.com/Top/Science/Technology/Electronics/)

Add another?

[webmaster@wescomponents.com](mailto:webmaster@wescomponents.com)

## LCD TV INVERTER BOARDS

### DEIMEN PARTS FOR LCD & PLASMA TV MONITORS

Due to the extensive range of inverter boards to select from to suit LCD & Plasma TVs from the entire international market we have not prepared a listing for our catalogue. So, instead: Please visit our website for an up-to-date listing of availability

You can either use the website search system to find your model  
Or download the latest PDF catalogue for you to print if you prefer

Initially there may be some delays in supplying stock but as a usage pattern develops we will keep the more popular items in stock as we do with the Flyback Transformers.

### SEND ANY STOCK SUGGESTIONS TO..

New products manager: [products@wes.net.au](mailto:products@wes.net.au)

When replying please quote the HR Reference Number and indicate if your recommendation is a stocking suggestion and/or if you definitely require the item and would like it sent to you, etc.

### DOWNLOAD PDF CATALOGUE

A listing of the latest range of Diemen LCD Inverter boards is available as a PDF Download (Currently 67 pages 5Mb)  
Download from: [www.wescomponents.com/hr](http://www.wescomponents.com/hr)

<http://www.wescomponents.com/hr>

For our grouping of relevant links and downloads.

<http://www.hrdiemen.es>

For downloading the latest EHT &amp; LCD listing in PDF.

<http://www.hrshop.es>

For an easy to use, always up-to-date search system.  
Then you can order the item from WES Components  
Take note of the HR-Diemen part number & description.  
If we don't carry stock, expect a delay as we order in.



## LCD BACK LIGHT TESTER FOR CCFL LAMPS

Make servicing large LCD TV's and monitors easier and faster using the new DIEMEN's CCFL Lamp Analyser. Test the panel-mounted lamp without having to dismantle the entire PANEL and without having to unplug the different connectors that are interacting between the inverter plate and lamps. (Note. The TV/Monitor must be disconnected from mains before testing). The Analyser will then indicate whether the Lamp is faulty and needs replacing or if the LAMP is working and there is another fault, in most cases the inverter board will be the cause of the fault and needs to be replaced.  
Includes 12V DC power supply.

Code TL1040

